



Model No : TLY-MB-A-9XK-0D-01

Spec No.	Date	Page	Ver.
/	Feb/23/2016	1/8	A2

# Jiang Xi TALOYA Technology CO. LTD.

## SPECIFICATION FOR APPROVAL

Company Name: \_\_\_\_\_

Product Name: LED Round Panel Light

Part No: TLY-MB-A-9XK-0D-01

Description: AC100-240V 50/60Hz

Your Part No: \_\_\_\_\_

For customer filling			
Confirmed department.			
Confirmed result			
(Signature)			
Finally result			

Approve	Auditing	Make
Hailin Zhou	Haimin Guo	Martin Liu

**SHENZHEN Add:**  
**613, Huanancheng Development Center, Pinghu St., Longgang Dist., Shenzhen,**  
**Guangdong, China (Mainland)**  
 TEL: 86-755-84669045 FAX: 86-755-84573610 Email: tw@taloya.cn www.taloya.com

Spec No.	Date	Page	Ver.
/	Feb/23/2016	2/8	A2

## Product Description

- ◆ Energy saving—Have constant current driver, ultra-low power consumption, high efficiency
- ◆ Environmental—No UV & infrared radiation, Light without the heat, more soft light.
- ◆ Super bright—Use high bright LED, vertical illuminance is exceed to other factory's.
- ◆ Long life—Up to more than 20,000 hours.
- ◆ Attractive appearance—With bright appearance, non-pollution and slim and light, easily installed without fixed holder

## Product Picture



## Product Dimensions

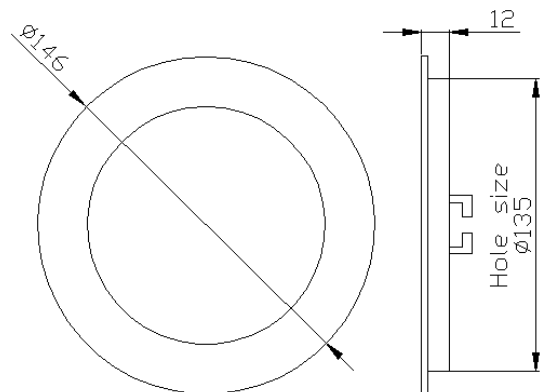

## Application area

It can totally replace fluorescent lamp, applications in various areas of lighting. Such as hotels, bars, supermarkets, restaurants, museums, exhibition halls, conference room, shops, warehouses, home lighting and other places.

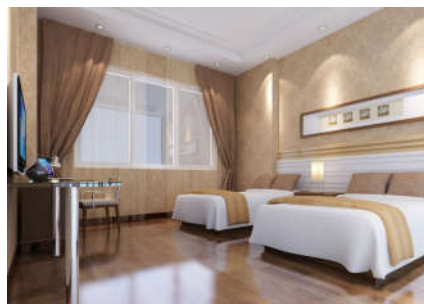
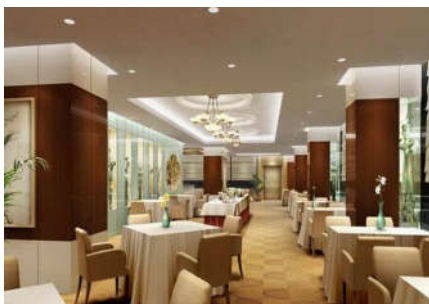

## Average illumination figure

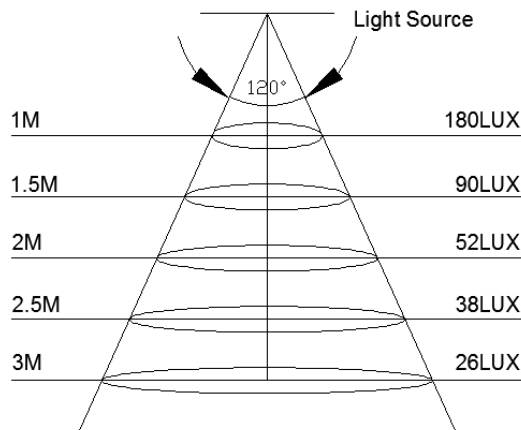

## Device Selection Guide

Part No.	Color	Dom. Wavelength or CCT(Typ.)	Lumen		LED Type
			Typ.	Max	
TLY-MB-A-9CK-0D-01	Cool white	6500K	650	750	SMD 2835
TLY-MB-A-9WK-0D-01	Warm white	3000K	650	750	SMD 2835

Note: [1] If you have any special request, please contact with our salesmen.

## Technical Parameter at $T_A=25^{\circ}\text{C}$

Items	Symbol	Min.	Typ.	Max.	Units
Power Consumption	P	8.5	9	9.5	W
Single loop input Voltage (AC) <sup>[1]</sup>	$V_i$	100	---	240	V
Single loop input current (AC) <sup>[1]</sup>	$I_f$	55	---	145	mA
Viewing Angle	VA	115	120	125	Deg.
Surface Temperature in Operation Condition	/	-20	---	40	$^{\circ}\text{C}$
Surface Temperature in Storage Condition	/	-40	---	55	$^{\circ}\text{C}$
Lifespan	H	---	20000	---	H

Note: [1] It is recommended to use the typical input voltage to drive LED light. The unsuitable input voltage will damage the LED light or reduce the life of product.

Spec No.	Date	Page	Ver.
/	Feb/23/2016	4/8	A2

## ■ Integrating sphere test data

- ◆ Cool white

Spec No.	Date	Page	Ver.
/	Feb/23/2016	5/8	A2

## LED Test Report

**Product Mark**

Product Type :TLY-MB-A-9CK-0D-01      Manufacturer :TALOYA  
 Temperature :25'C      Humidity :75%  
 Operator :Martin      Test Date :2015-09-08

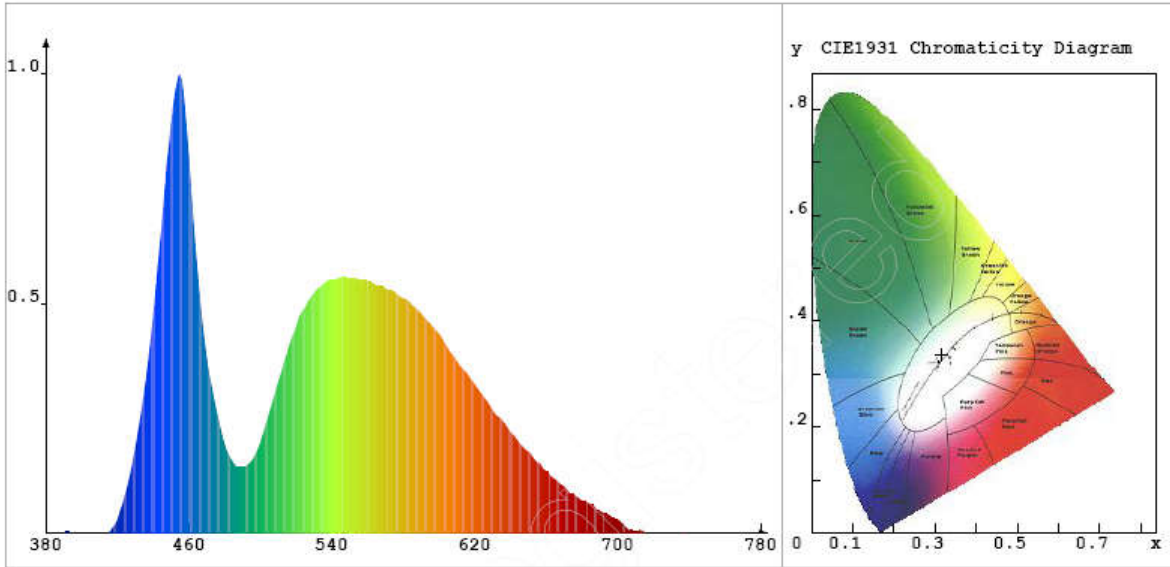

**Chroma Parameters**

Chro.Coor.: x=0.3162    y=0.3378    u=0.1970    v=0.3156    duv=0.0059  
 CCT: Tc= 6269K    Dominant Wave.: 496.1nm    Purity: 5.5%  
 R ratio: R= 12.3    Peak Wavelength: 454.5nm    Half Width: 25.8nm

**Rending Index: Ra= 73.6**

R1 =69.7    R2 =79.2    R3 =83.3    R4 =70.7    R5 =69.8    R6 =70.5    R7 =85.9  
 R8 =59.9    R9 =-28.0    R10=48.2    R11=65.2    R12=36.5    R13=72.1    R14=90.5  
 R15=65.3

**Photo Parameters**

Flux: 659.75lm      Effi.: 72.5lm/W      RadiantPower: 2285.6mW

**Ele. Parameters**

Voltage:U=219.0V      Current:I=0.066A  
 Power:P= 9.1W      Power Factor:PF=0.635

**Instrument state**

IntgeTime: 222.724ms      VPeak: 13807      VDark: 1377  
 Scan Range: 380-780nm

◆ Warm white

Spec No.	Date	Page	Ver.
/	Feb/23/2016	6/8	A2

## LED Test Report

**Product Mark**

Product Type :TLY-MB-A-9WK-0D-01  
 Temperature :25'C  
 Operator :Martin

Manufacturer :TALOYA  
 Humidity :75%  
 Test Date :2015-09-08

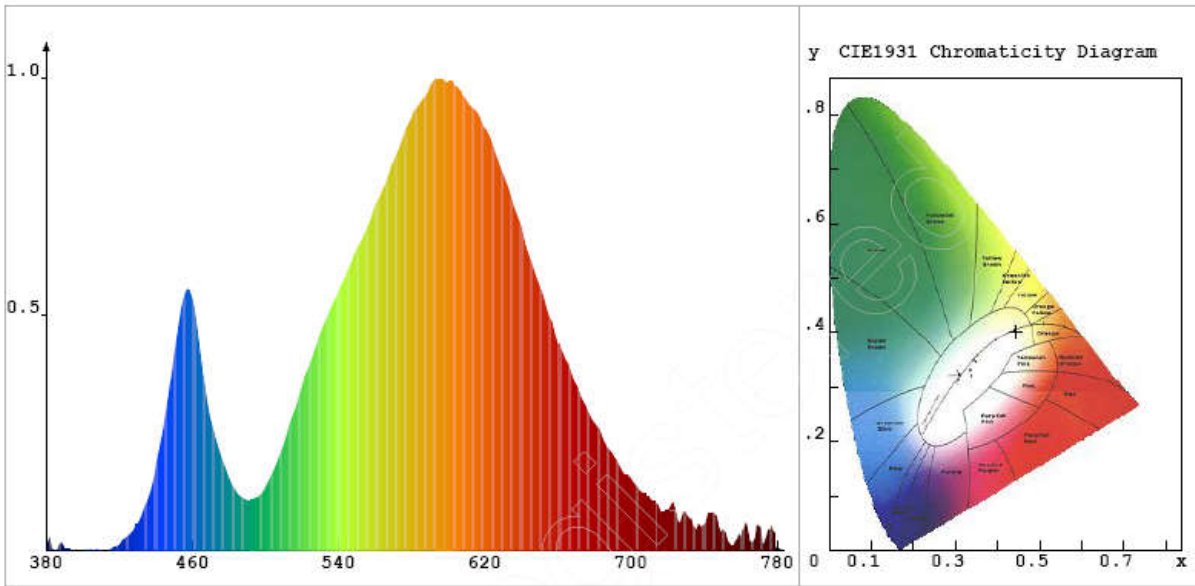

**Chroma Parameters**

Chro.Coord.: x=0.4447 y=0.4011 u=0.2569 v=0.3476 duv=-0.0021  
 CCT: Tc= 2848K Dominant Wave.: 585.3nm Purity: 53.9%  
 R ratio: R= 22.7 Peak Wavelength: 592.6nm Half Width: 120.2nm

**Rending Index: Ra= 73.9**

R1 =71.1 R2 =85.1 R3 =94.1 R4 =67.0 R5 =69.3 R6 =78.2 R7 =78.5  
 R8 =48.6 R9 =-14.8 R10=63.5 R11=59.0 R12=50.8 R13=74.0 R14=96.5  
 R15=66.0

**Photo Parameters**

Flux: 659.88lm Effi.: 73.32lm RadiantPower: 2856.2mW

**Ele. Parameters**

Voltage:U=217.0V Current:I=0.066A  
 Power:P= 9.0W Power Factor:PF=0.630

**Instrument state**

IntgTime: 96.424ms VPeak: 9541 VDark: 947  
 Scan Range: 380-780nm

Spec No.	Date	Page	Ver.
/	Feb/23/2016	7/8	A2

## Connection

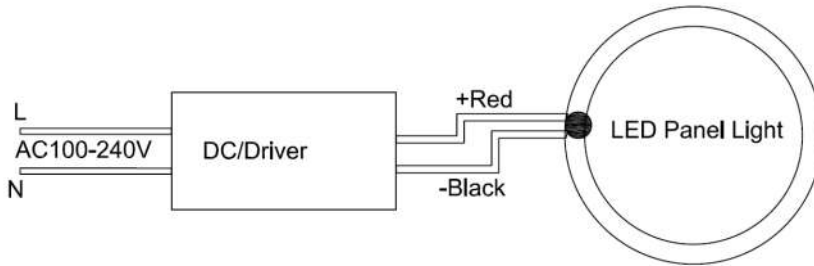

## Installation Instruction

◆ **Attention:** Before installation, power must be cut off to keep people safe.

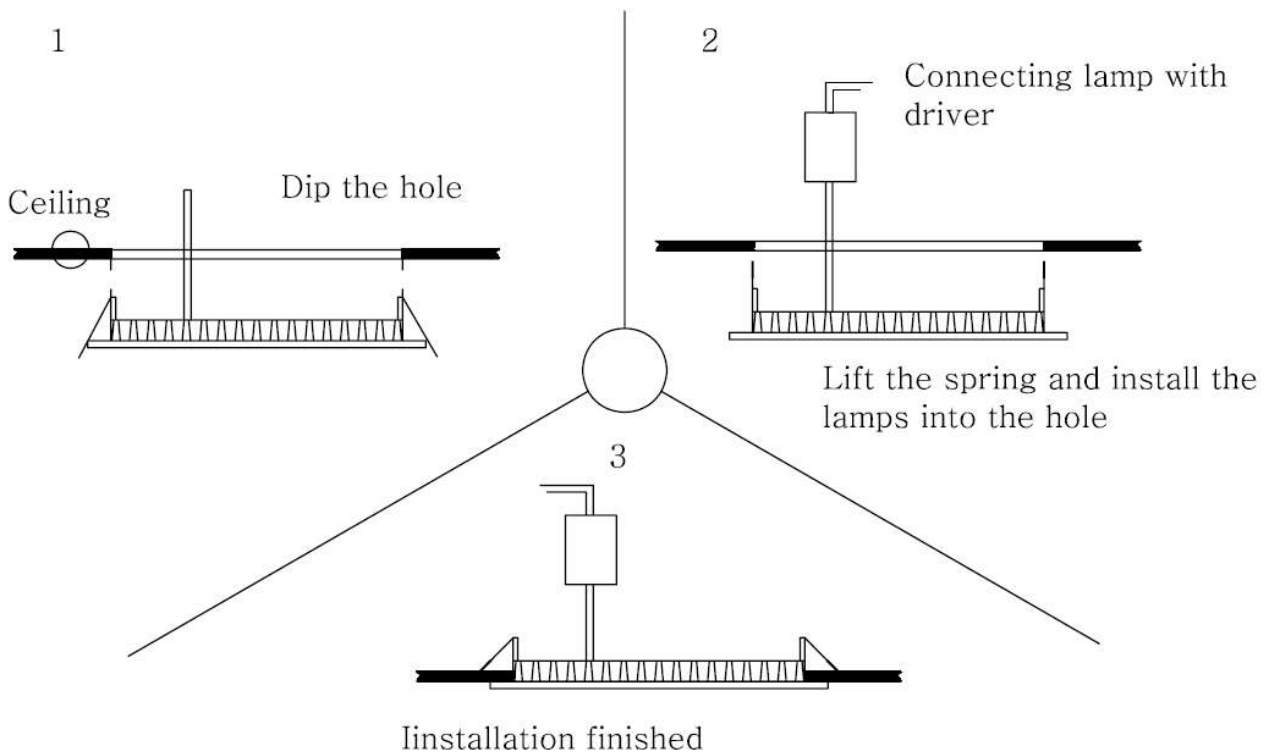

Notice: turn off the light before install or uninstall

## ■ The view of package

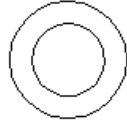

Panel light

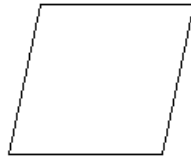

PE bag

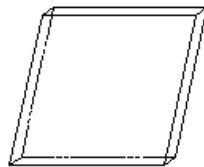

Inner box

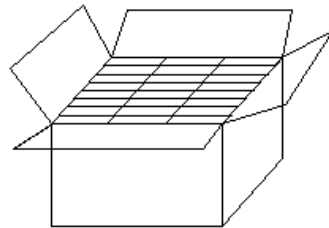

30pcs/Carton

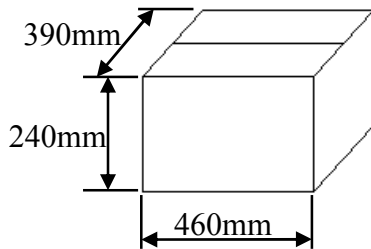

Sealed carton

Size of panel(mm)	∅ 146*12mm
Hole size(mm)	∅ 135mm
Inner box size	L*W*H: 183x214x28mm
Carton size	L*W*H: 460x390x240mm
Packing quantity	30pcs
Net weight	5.31kg
Gross weight	---kg